Comfort-Aire®

Century®



REPLACEMENT PARTS LIST

**Low Temperature Mini-Split
Indoor Ducted Unit**

B-VMH09DU-1

EXPLODED VIEW

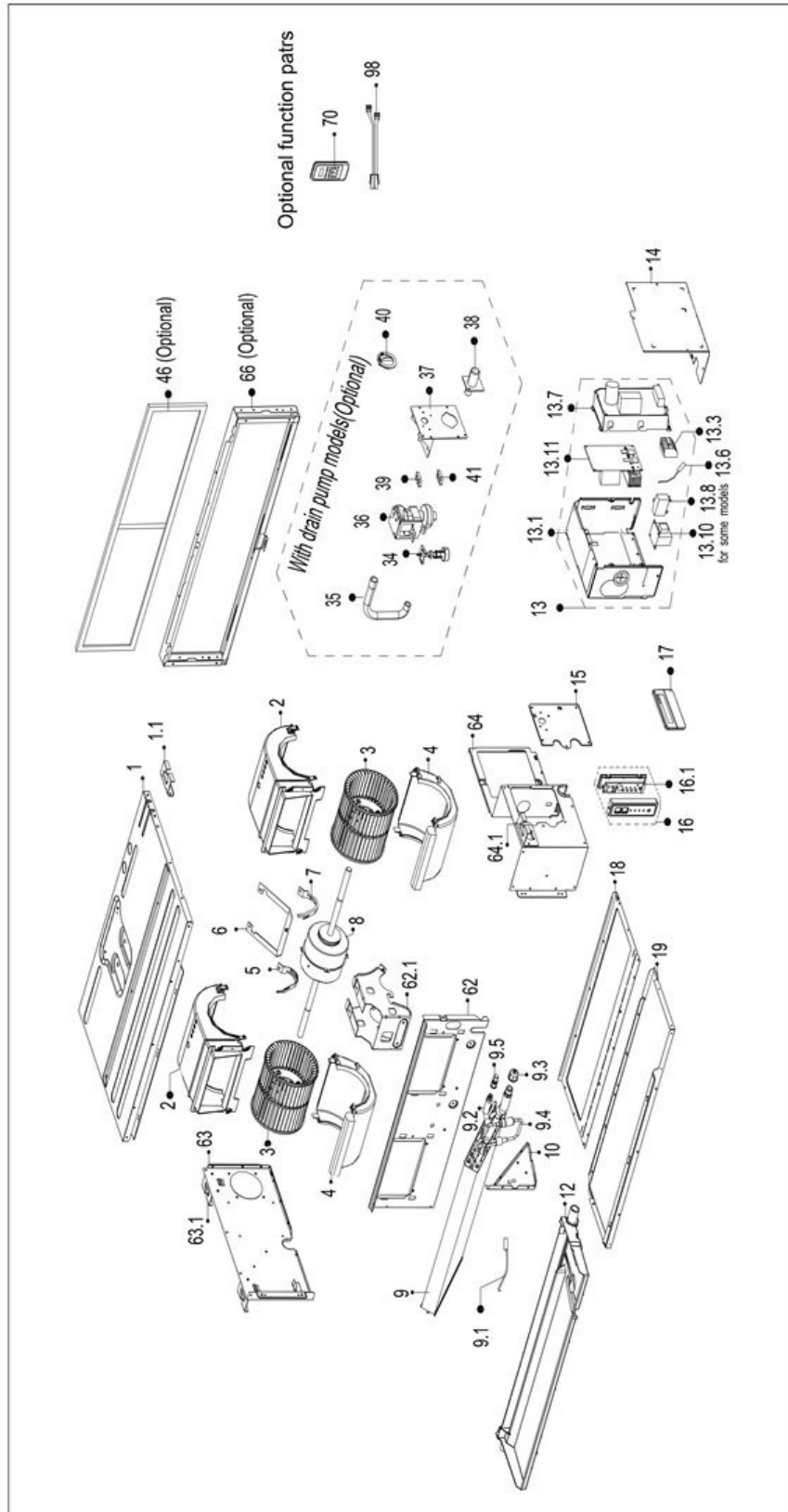

REPLACEMENT PARTS

Location	Part Name	Quantity	Part No.
1	Chassis subassembly	1	12223000010324
2	Top volute subassembly	2	12123000001180
3	centrifuge fan	2	12100103000804
4	bottom volute	2	12123000001161
5	Fan motor clamp (left)	1	12222500000253
6	Fan motor fixing bracket	1	12223000010427
7	Fan motor clamp (right)	1	12222500000255
8	Brushless DC Motor	1	11002015006981
9	Evaporator Assembly	1	15823000004321
9.1	Pipe Temperature Sensor	1	11201007000070
9.2	Evaporator outlet pipe subassembly	1	15123000010747
9.3	Pipe Nut	1	15500404000002
9.4	Evaporator inlet pipe subassembly	1	15123000010589
9.5	detection valve	1	15500209000001
10	Evaporator right support board subassembly	1	12223000010316
12	Water pan components	1	12123000001164
13	E-Parts Box assembly	1	17223000005236
13.1	Electronic control box	1	12223000010447
13.3	Wire joint	1	17400401000075
13.6	Room Temperature Sensor	1	11201007000283
13.7	Main control board subassembly	1	17123000004312
13.10	Reactor	1	17400306000070
13.11	Inverter module subassembly	1	17122000038512
14	Cover of electronic control box	1	12223000010314
15	Pipe clamp board subassembly	1	12223000010317
16	Duct display board subassembly	1	17223000000003
16.1	Duct display board subassembly	1	17123000002712
17	Wired controller	1	17317100001195
18	Rear cover subassembly	1	12223000010323
19	Top cover subassembly	1	12223000010326
46	Air filter	1	12223000A03901
62	Middle beam subassembly	1	12223000010325
63	Left side plate assembly of cabinet	1	12223000010311
63.1	Hook	2	12223000006628
64	Right clapboard subassembly	1	12223000010320
64.1	Hook	1	12223000006628
66	Right clapboard subassembly	1	12223000A03903

Due to ongoing product improvements, specifications and dimensions are subject to change and correction without notice or incurring obligations. Determining the application and suitability for use of any product is the responsibility of the installer. Additionally, the installer is responsible for verifying dimensional data on the actual product prior to beginning any installation preparations.

Incentive and rebate programs have precise requirements as to product performance and certification. All products meet applicable regulations in effect on date of manufacture; however, certifications are not necessarily granted for the life of a product. Therefore, it is the responsibility of the applicant to determine whether a specific model qualifies for these incentive/rebate programs.

Comfort-Cire®  **Century**®

1900 Wellworth Ave., Jackson, MI 49203 • Ph. 517-787-2100 • www.marsdelivers.com

